

1: Product Introduction	1
2: Product Features	1
3: Product Parameters	1
4: Product Parts List	3
5: Product Part Name	3
6: Product Instructions	4
7: Notes	5

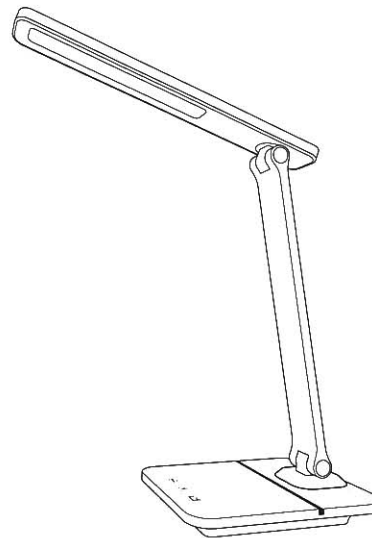

TD-619S

LED Lamp

Please read this manual carefully before using the product and keep it properly.

## 1. Product Introduction

LED desk lamp, using long aspect design, luminous effect is wide, three kinds of color temperature can be adjusted, brightness can be adjusted arbitrarily, no video flash, light clear and comfortable.

## 2. Product Features

- |                                       |                       |
|---------------------------------------|-----------------------|
| 1. Three color temperature adjustment | 2. Stepless dimming   |
| 3. Timer mode                         | 4. Flicker Free       |
|                                       | 5. Foldable Lamp Head |

## 3. Product Parameters

Product model: TD-619S-CDW  
Product material: ABS  
Product color: white  
Rated voltage: 5V  
Product power:  
10W (30X0.5W/LEDmodule  
+ Wireless charging module\*1)  
Rated current: 2A  
Light source: LED  
Color rendering index (Ra) : >80  
Working temperature: -5 ~ +45  
Color temperature:  
3000K-4000K-6000K  
Luminous flux: ≈425LM  
Product weight: ≈680g  
Product size: 125\*171.5\*336MM  
Packing size: 130\*60\*350MM

Product model: TD-619S-CDWK  
Product material: ABS  
Product color: white  
The input: 5V-12V = 2.5A  
Light source: LED  
Color rendering index (Ra) : >80  
Working temperature: -5 ~ +45  
Color temperature:  
3000K-4000K-6000K  
Luminous flux: ≈425LM  
Product weight: ≈680g  
Product size: 125\*171.5\*336MM  
Packing size: 130\*60\*350MM

Product model: TD-619SLI-CDW  
Product material: ABS  
Product color: white  
Rated voltage: 5V  
Product power:  
10W (30X0.5W/LEDmodule  
+ Wireless charging module\*1)  
Rated current: 2A  
Battery category:  
18650 lithium battery  
Battery capacity: 2000mAh  
Charging time: ≈3hours  
Discharge time: 3~5hours  
Light source: LED  
Color rendering index (Ra) : >80  
Working temperature: -5 ~ +45  
Color temperature:  
3000K-4000K-6000K  
Luminous flux: ≈425LM  
Product weight: ≈680g  
Product size: 125\*171.5\*336MM  
Packing size: 130\*60\*350MM

-1-

Product model: TD-619S-CD  
Product material: ABS  
Product color: white  
Rated voltage: 5V  
Product power:  
5W (30X0.5W/LEDmodule )  
Rated current: 1A  
Light source: LED  
Color rendering index (Ra) : >80  
Working temperature: -5 ~ +45  
Color temperature:  
3000K-4000K-6000K  
Luminous flux: ≈425LM  
Product weight: ≈680g  
Product size: 125\*171.5\*336MM  
Packing size: 130\*60\*350MM

Product model: TD-619SA  
Product material: ABS  
Product color: white  
Rated voltage: 5V  
Product power:  
10W (30X0.5W/LEDmodule )  
Rated current: 2A  
Battery category:  
18650 lithium battery  
Battery capacity: 1800mAh  
Charging time: ≈3hours  
Discharge time: 3~5hours  
Light source: LED  
Color rendering index (Ra) : >80  
Working temperature: -5 ~ +45  
Color temperature:  
3000K-4200K-6400K  
Luminous flux: ≈425LM  
Product weight: ≈720g  
Product size: 125\*171.5\*336MM  
Packing size: 130\*60\*350MM

Product model: TD-619S  
Product material: ABS  
Product color: white  
Rated voltage: 5V  
Product power:  
5W (30X0.5W/LEDmodule )  
Rated current: 1A  
Battery category:  
18650 lithium battery  
Battery capacity: 2000mAh  
Charging time: ≈3hours  
Discharge time: 3~5hours  
Light source: LED  
Color rendering index (Ra) : >80  
Working temperature: -5 ~ +45  
Color temperature:  
3000K-4000K-6000K  
Luminous flux: ≈425LM  
Product weight: ≈720g  
Product size: 125\*171.5\*336MM  
Packing size: 130\*60\*350MM

Product model: TD-619SA-CD  
Product material: ABS  
Product color: white  
Rated voltage: 5V  
Product power:  
10W (30X0.5W/LEDmodule )  
Rated current: 2A  
Light source: LED  
Color rendering index (Ra) : >80  
Working temperature: -5 ~ +45  
Color temperature:  
3000K-4200K-6400K  
Luminous flux: ≈425LM  
Product weight: ≈680g  
Product size: 125\*171.5\*336MM  
Packing size: 130\*60\*350MM

-2-

## 4. Product Parts List

LED Desk Lamp \*1  
User Manual \*1

## 5. Product Part Name

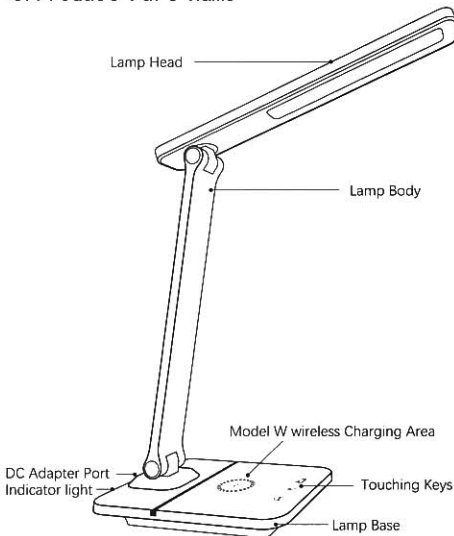

-3-

## 6. Product Instructions





(1): TD-619S-CD: Connect one end of the USB cable to the computer/mobile power/ power adapter and the other end to the product. The indicator light is red.

TD-619S: Connect one end of the USB cable to the computer/mobile power/ power adapter and the other end to the product. The indicator light is red. At the same time, the product will be charged, and the rear indicator will go off when full.

TD-619S-CDW/619SA-CD: Connect the USB cable to the 5V=2A power adapter, connect the product to the other end, and the indicator will be bright red.

TD-619SLI-CDW/619SA: Connect the USB cable to the 5V=2A power adapter, connect the product to the other end, and the indicator will be bright red. At the same time, the product will be charged, and the rear indicator will go off when full.

TD-619S-CDWK: Connect the USB cable to the 5V-12V=2.5A power adapter, connect the product to the other end, and the indicator will be bright red.

- (2): Press  for about 1 second, and the lamp mode will be on. At this point, the lamp will be bright white, then yellow, then warm, and then the lamp will be off. Long press this button for 3 seconds at any color temperature to adjust the brightness of the lamp. Press  and the light will turn off automatically after about 10 minutes of warm yellow light. Open Highlighting mode when you press . When the lamp with model W is connected to the power supply, put the mobile phone with wireless charging and suitable for the lamp on the  pattern and turn on the wireless charging function. The charging duration varies with the mobile phone.
- (3): The end of the product has the function of USB charging transfer. When the product is connected to the power supply, it can charge the mobile phone at the same time. There is no function when the product is not connected to the power supply.

-4-

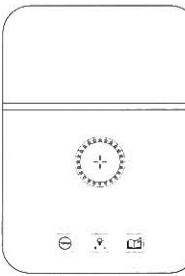

Touching Panel

## 7. Notes

### Warning:

- The product does not have waterproof function, do not use it in a wet environment.
- Please do not disassemble the product by yourself.
- To avoid danger, do not cover the product.
- Keep children away from the lamp, this product is not a children's lamp/toy.
- Cut off the power supply quickly in case of abnormal phenomenon, and contact with the seller.

### Note:

- The light source of the secondary lamp is not replaceable. When the light source reaches the end of its life, the whole lamp should be replaced.
- This lamp shall not be used on an inclined plane of more than 6°.
- This product charging mouth has the function of charging for mobile phones and other electronic products positive wireless charging device for a wireless charging and charging the mobile phone function for matching on this desk lamp, also has the function of desk lamp, as the goods can be normal use, not recommended three function used at the same time, can use two functions at the same time.

-5-

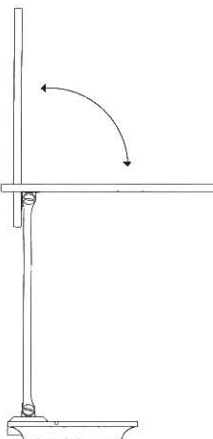

Prevent 6° tipping table lamp adjustment range shown in figure

-6-